



Semi Automatic Pallet Wrapping Machine

With Remote Control and Power Pre-stretch Head



X200

- ✓ Our new X200 Advanced model now welds the film after cutting (Or stick with our standard model with cut clamp and wipe function)
- ✓ 250% Powered Pre-stretch 1000m stretches to 2500m
- ✓ 1800mm Turntable suits Standard Australian Pallets 1165mm x 1165mm pallet. (2000mm/2200mm turntables are optional)
- ✓ Various wrapping height available standard is 2350mm
- ✓ 2000kg Load Capacity
- ✓ Pallet Clamp System (Roping)
- ✓ Automatic Load Roping System - Got to see it to believe it
- ✓ Film Carriage Safety Door with Sensor
- ✓ Remote Control * No need to get off your forklift
- ✓ Touch Screen Operation
 - (can save up to 12 programs for various different wrapping needs)
- ✓ Intelligent Alarm System with LED Indicator
- ✓ New XLINE system allows for remote connection for servicing (Ethernet cabling and internet connection required)
- ✓ PLC (SIEMENS)
- ✓ Inverter (SIEMENS)
- ✓ Photocell for auto height detection (SICK)
- ✓ Loading Ramp (optional extra)
- ✓ Weight Scales (optional extra)
- ✓ Top Press Device (optional extra)



Remote Control Operation * 2 Year Warranty * LCD Touch Screen Display



Semi Automatic Pallet Wrapping Machine

With Remote Control and Power Pre-stretch Head



X200

Pallet Clamping System

Picture this: every year, a whopping 20 million loads go rogue, slipping off their pallets in transit and leaving a jaw-dropping \$6 billion trail of damaged goods. It's a costly mess caused by one simple thing: loads not being securely bonded or "locked" onto the pallet during shipment. But here's the kicker: traditional stretch wrapping, just wrapping down to the base of the pallet, won't cut it. Those pesky puncture holes from forklift forks or pallet jacks can creep up, compromising the wrap's strength and leaving your cargo vulnerable to shipping disasters.

Enter the game-changer: our Pallet Clamping System. With this bad boy, your wrap only needs to extend a mere 10mm past the top board of the pallet. That's it - no fuss, no hassle. The best part? Our Pallet Clamping System is a universal fit, working seamlessly with any type of pallet. Say goodbye to damaged goods and hello to peace of mind.

So, how do we achieve this pallet clamping magic? Simple. As the film swoops down towards the pallet, we start rolling the bottom, creating a sturdy "rope" that holds your load and pallet together like glue. It's tough, it's resilient, and it's the ultimate clamp-down your cargo needs.



Load Roping

Let's chat about "Load Roping" on our X200 Advanced. Our automatic electrical variable roping device is a real game-changer. It takes that 500mm roll of film and does wonders, turning it into a full-on rope or a flexible band, giving your load top-notch protection. But roping isn't just about securing your load; it's also about letting it breathe and keeping condensation at bay.

Now, let's get into the details. Our roping device hooks right up to the film carriage and gets to work roping the entire web of film from top to bottom. Starting from the top ensures we apply a solid rope of film right where your load needs it most, ensuring it stays sturdy as a rock. And here's the kicker - with our roping device, you can flick it on or off at up to nine different preset spots on each load. That's what I call precision and flexibility!

Roping is the bee's knees it is the next best thing to strapping your load before wrapping, and in some cases even better. It's unbeatable at keeping everything snug, especially for businesses that wrap drums or other tall, skinny items. Once you've given "load roping" a try, you'll wonder how you ever managed without it. Trust me, it's a game-changer.

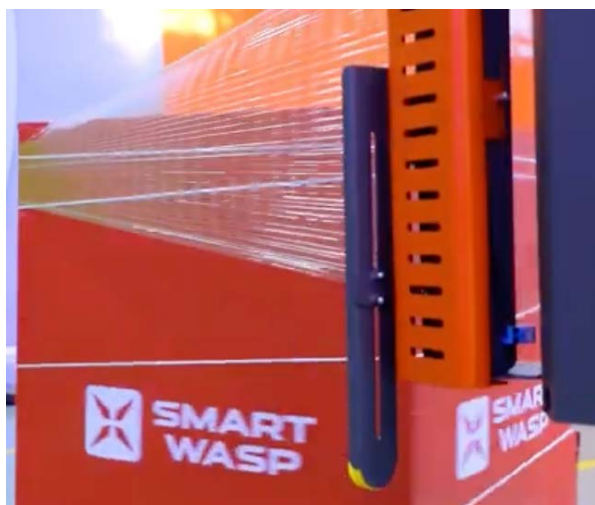

Pallet Clamping * Load Roping * Advanced Safety Features



Semi Automatic Pallet Wrapping Machine

With Remote Control and Power Pre-stretch Head



X200

Automatic Cut, Clamp and Film Wipe

(Say goodbye to loose film tails) Exclusive to the X200, our automatic cut, clamp, and film wipe system revolutionizes your wrapping process. With this feature, your operators no longer need to hand-cut the film or manually attach it to the pallet - our system handles it all automatically. The wiping arm smoothly pushes the film's end against the pallet wrap, and thanks to the film's cling, it usually stays put. Say farewell to those unsightly film tails that used to require manual tucking under the wrap. It's a game-changer.



Automatic Clamp, Cut and Film Welding

The X200 Advance now has the film welding feature. Much Like the X200 at the end of the wrapping cycle the clamp holds the film whilst the swinging arm cuts the film but, here were the fun starts at this point our welding head welds the tail of the film to the film that is already on the pallet. It's bloody brilliant. Loose tails are now a thing of the past. Check out our video, you need to see it to believe it.



Remote Control Operation

Your forklift operator just places the pallet on the turntable them starts the machine from the comfort of their forklift with the remote control (Easy Peasy) .

Many operators are hurt each year jumping on and off forklifts. It a critical Health and Safety issue. Just avoiding one back issue will pay for this machine.

But lets not forget the savings from increased productivity. Even just wrapping 60 pallets per day is going to increase your operators productive time by about 30 minutes.

The combination of a reduction in risk and an increase in productivity makes our X200 range a no brainer.



Remote Control Operation * No More Loose Tails With Our Film Welding Feature



Semi Automatic Pallet Wrapping Machine

With Remote Control and Power Pre-stretch Head



X200

With the latest cost-saving power pre-stretching film carriage

1. Use the touch screen to precisely adjust the wrapping tension
2. The pre-stretching ratio is 250%, giving you impressive film saving

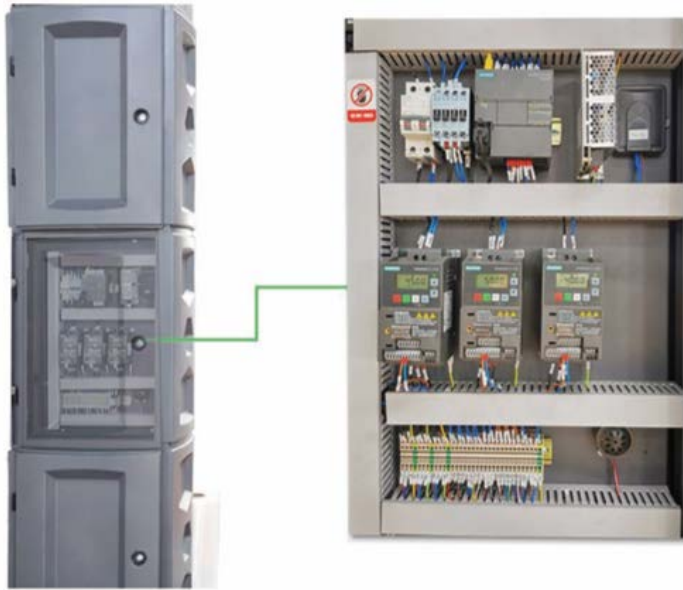

Only the best Electronic Components

1. SIEMENS PLC
2. SICK Proximity Switches
3. AUTONICS Photoelectric Switch
4. WEIDMULLER Terminal Blocks
5. XLINE Inverter



Intuitive and Easy to Operate Touch Screen

- 5 Memory Functions on X200
- 12 Memory Functions on X200 Advanced

1. Easy to operate clear bright touch screen that your operators will love
2. Program memory function, make parameter setting easier with simple recall
3. Two levels of Password protection to stop those that like to play with setting
4. One button to start the wrapping cycle ensures convenient simple operation

Machine Column, Film Carriage and Safety

1. Available in three wrapping heights.
Standard 2,350mm
Optional 2,750mm
2. Safe and secure belt drive carriage system
3. Tri colour indicator light
Green - in operation
Blue - ready to go
Red - Error
4. Film Carriage with safety plate ensure the machine stops rather than squashing heads hands or product
5. Emergency Stop Button



NEW
X200 SMART WASP



Smart Manufacturing & Packaging Solutions
www.pallet-stretch-wrapping-machines.com.au
 Phone 1300 722 868

Model	X200	X200 Advanced
Pre Stretch Film Head	250% Standard (200% or 300% optional)	
Maximum Load	2,000kgs	
Turn Table Soft Start	Yes	
Turntable Speed	3 to 12 RPM (Adjustable in up to 9 different zones via Touch Screen)	
Up and Down Speed	1.5m to 5.5m/min (Adjustable in up to 9 different zones via Touch Screen)	
Wrapping Force	0 to 100% (Adjustable in up to 9 different zones via Touch Screen)	
Maximum Wrapping Height	2,350mm (2,750mm Optional)	
Turntable Diameter	1,800mm suits Standard Australian Pallets 1,165mm x 1,165mm (2,000mm and 2,200mm Optional)	
Applying Film to Pallet	Automatic	
Pallet Clamping (Roping)	Yes	
Load Roping	No	Yes
Auto Film Cutting	Clamp - Cut - Wipe	Clamp - Cut - Weld
Program Memory	5	12
Height Sensor	Standard	Black Light Sensor (Blue Optional)
Wrapping Speed	20-30 Pallets per hour (1.2x1.2x1.8 one each up and down layer)	
Indicator Light	BLUE ready to run - GREEN running a cycle - RED fault detected	
Intelligent Resetting Guide	Yes	
Password Protection	Yes (2 Levels)	
Recommended Film	Smart Wasp Nano Wrap (Other Solid and Vented Films suitable for Pre-stretch Head)	
Film Width	500mm (750mm Optional)	
Film Core ID	76mm (50mm Optional)	
Film OD	250mm maximum	
Film Weight	15Kgs	
Machine Weight	750Kgs	
Machine Power	1.5kW	
Machine Voltage	Standard Australian 230VAC with Standard 10 amp plug	
Compressed Air Supply	6 - 7 Bar	
Machine Dimensions	Length 2,710mm - Width 1,800mm - Height 2,740mm (3,140mm Optional)	
Optional Functions		
Top Press Function	Yes	
Ramp	Yes	
Weight Scales	Yes	

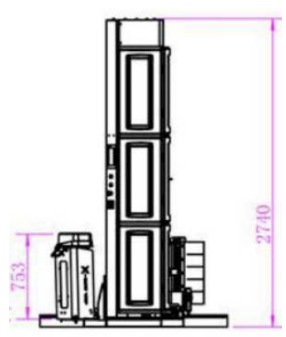
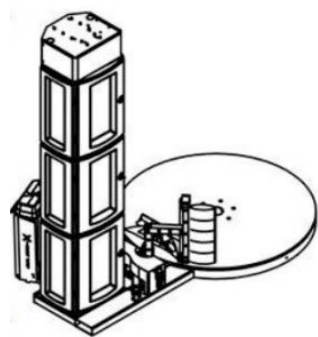
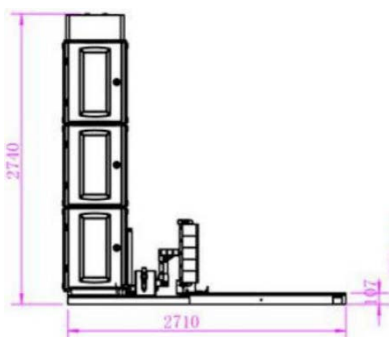



Semi Automatic Pallet Wrapping Machine With Remote Control and Power Pre-stretch Head



NANO HIGH-QUALITY SUPER STRETCH FILM



Introducing the very best film for your pallet wrapper

Smart Wasp Nano High-Quality Super Stretch Film is a durable and versatile Machine Pallet Wrapping Film for all your packaging needs, providing reliable protection for your products during storage and transportation. Made from high-quality materials that provide superior strength and durability, allowing it to withstand the rigors of transport and storage. It is also highly stretchable up to 400%, allowing for a snug and secure fit around your products.

Our film is designed to be used with ease and efficiency, and it is compatible with our full range of Pallet Wrapping Machines. At just 14um it is stronger than most 23um films due to its incredible 31 layers within its 14um thinness. Due to its incredible thinness our rolls have 2140m per roll, so when comparing prices, always compare the price per metre, as our competitors often only have 1300m to 1500m per roll.

With our Nano High-Quality Super Stretch Film, you can be confident that your products will remain safe and secure throughout the entire supply chain.